

mitsubishi

cm ³	∅	Motor	Cylinder	Index
1198	68,2	Benzin	4	1
1198	68,2	Benzin	4	2
1244	69,5	Benzin	4	3
1410	74,0	Benzin	4	5
1439	73,0	Benzin	4	4
1468	75,5	Benzin	4	6
1468	75,5	Benzin	4	7
1596	82,3	Benzin	4	20
1597	76,9	Benzin	4	8
1597	76,9	Benzin	4	9
1597	76,9	Benzin	4	10
1597	76,9	Benzin	4	11
1597	76,9	Benzin	4	12
1597	76,9	Benzin	4	13
1755	80,6	Benzin	4	14
1755	80,6	Benzin	4	15
1795	80,6	Benzin	4	16
1795	80,6	Benzin	4	17
1795	80,6	Diesel turbo	4	18
1795	80,6	Diesel turbo	4	19
1995	84,0	Benzin	4	21
1997	85,0	Benzin	4	22
1997	85,0	Benzin	4	23
1997	85,0	Benzin	4	24
1997	85,0	Benzin turbo	4	25
1997	85,0	Benzin	4	26
1997	85,0	Benzin	4	27
2346	91,1	Diesel	4	28
2346	91,1	Diesel turbo	4	29
2476	91,1	Diesel	4	28
2477	91,1	Diesel turbo	4	29
2555	91,1	Benzin	4	30

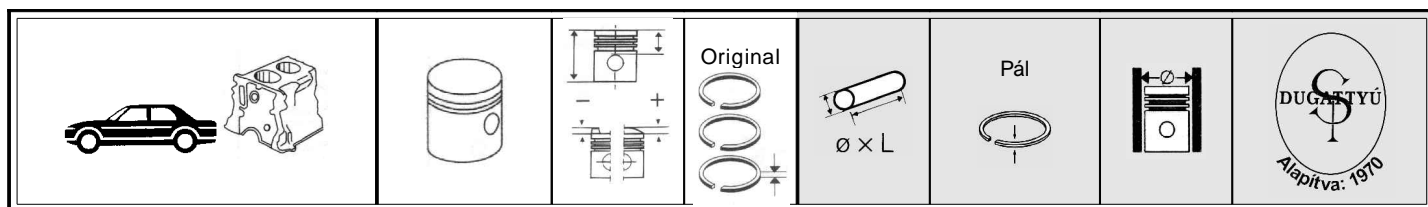

MITSUBISHI 4G16 1198 cm ³ benzin 1983- Lancer, Mirage 89	1	4 68,2	 	58,0 20,0 +4,2	1,5 1,5 4	18x60	1,5-1,5-4 1,5-1,75-3 1,5-1,5-2,8	Ø68,2 Ø68,7 Ø69,0	4328-0011 4328-5031 4329-8031
MITSUBISHI 4G16 N 1198 cm ³ benzin Lancer	2	4 68,2	 	58,5 20,25	1,5 1,5 2,8	18x56	1,5-1,5-2,8 1,5-1,5-2,8	Ø68,2 Ø69,0	T8246 T8248
MITSUBISHI 4G11 1244 cm ³ benzin 1978- Colt 1979- Lancer	3	4 69,5	 	58,8 20,0 +0,8	1,5 1,5 4	18x60	1,75-2-4 1,75-2-4 1,75-2-4	Ø69,5 Ø70,0 Ø70,5	05554 05556 05558
MITSUBISHI 4G33 1439 cm ³ benzin 1974- Celeste, Colt, 79 Galant, Lancer	4	4 73,0	 	69,7 23,6	2 2 4	19x65	1,75-2-4 1,75-2-4 1,6-2-4	Ø73,0 Ø73,5 Ø74,0	T04095 T04097 T8208
MITSUBISHI 4G12 1410 cm ³ benzin 1978- Colt 1979- Lancer 1982- Tredia	5	4 74,0	 	58,0 20,0 -1,5	1,5 1,5 4	18x60	1,6-2-4 1,6-2-4 1,75-2-4	Ø74,0 Ø74,5 Ø75,0	01261 02384 02386

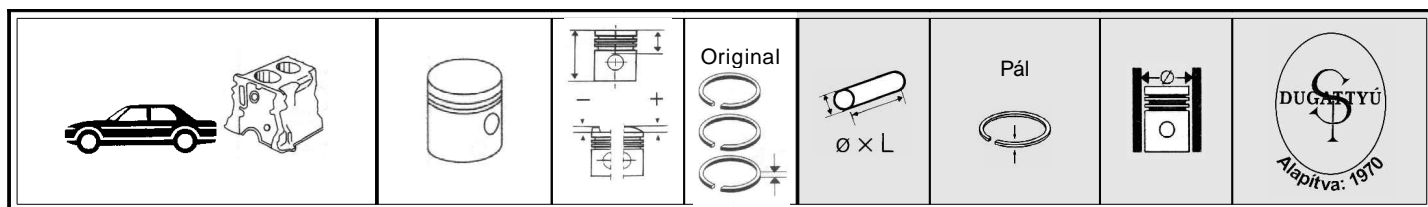

MITSUBISHI 4G15 1468 cm ³ benzin 1984- Colt, Lancer 1983- Tredia	6 4 75,5		58,0	1,5	18x60	1,5-1,5-3 1,5-1,5-2,8	Ø75,5 Ø76,0	01263 01265
			20,0 -0,7	1,5 4				

MITSUBISHI 4G15 1468 cm ³ benzin 1986- Colt, Lancer 90	7 4 75,5		58,6	1,5	18x60	1,5-1,5-3 1,5-1,5-2,8 1,5-1,5-2,8	Ø75,5 Ø76,0 Ø76,5	02980 02982 8128
			20,4 -3,8	1,5 4				

MITSUBISHI 4G32 1597 cm ³ benzin	8 4 76,9		70,5	2	19x65	2-2-4 2-2-4 2-2-4	Ø76,9 Ø77,4 Ø77,6	05443 05447 05445
			24,5 -2,3	2 4				

MITSUBISHI 4G32 1597 cm ³ benzin 1980- Galant 1979- Lancer, L300 1982- Cordia, Tredia	9 4 76,9		70,5	2	19x63	2-2-4 2-2-4 2-2-4 2-2-3 2-2-3	Ø76,9 Ø77,4 Ø77,6 Ø78,0 Ø78,5	04393 04395 04397 04981 04983
			24,0 -2,2	2 4				

MITSUBISHI 4G32 1597 cm ³ benzin Galant, Lancer Tredia, Cordia	10 4 76,9		70,5	2	19x63	2-2-4 2-2-4 2-2-4	Ø76,9 Ø77,4 Ø77,6	02954 02956 02958
			24,0 -5,7 perem: 5,5	2 4				

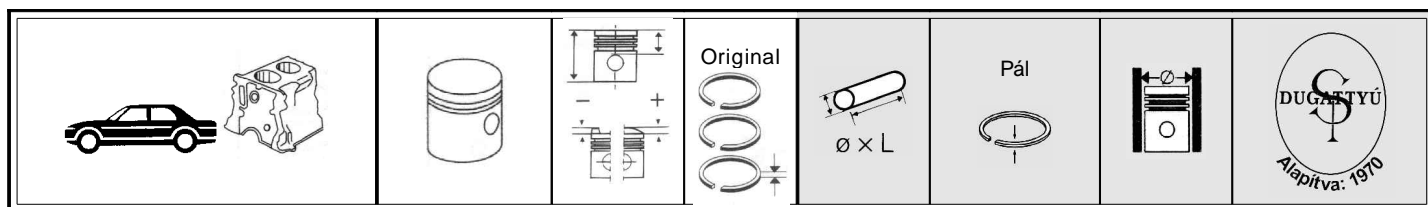

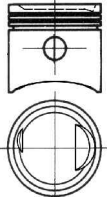
mitsubishi 4G32 1597 cm ³ benzin Delica, Galant, Forte, Lancer	11	4 76,9 	70,5	2	19x63	2-2-4	Ø76,9	02917
			24,0	2		2-2-4	Ø77,4	02919
			-3,7	4		2-2-4	Ø77,6	02921

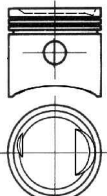
mitsubishi 4G32 L 1597 cm ³ benzin Delica, Galant, Lancer, Forte	12	4 76,9 	70,5	2	19x63	2-2-4	Ø77,4	05249
			24,0	2		1,75-2-3	Ø77,5	04363
			-0,9	4		2-2-4	Ø77,6	05251

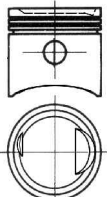
mitsubishi 4G32 S 1597 cm ³ benzin Delica, Galant, Lancer, Forte	13	4 76,9 	70,5	2	19x63	2-2-4	Ø76,9	02598
			24,0	2		2-2-4	Ø77,4	02600
			-0,5	4		2-2-4	Ø77,6	02602

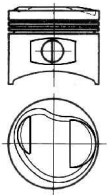
mitsubishi 4G37 1755 cm ³ benzin 1984- Lancer, Tredia, Cordia	14	4 80,6 	67,8	1,5	19x62	1,5-1,5-4	Ø80,6	6898-0011
			24,5	1,5		1,5-1,75-3	Ø81,0	6898-4031
			+3,5	4		1,5-1,75-3	Ø81,5	6898-9031

mitsubishi 4G37 1755 cm ³ benzin 1984- Cordia, Tredia Spacewagon 1986- Lancer	15	4 80,6 	69,0	1,5	19x65	1,5-1,5-4	Ø80,6	5375-0011
			24,3	1,5		1,5-1,75-3	Ø81,0	5375-4031
			+7,7	4		1,5-1,75-3	Ø81,5	5375-9031

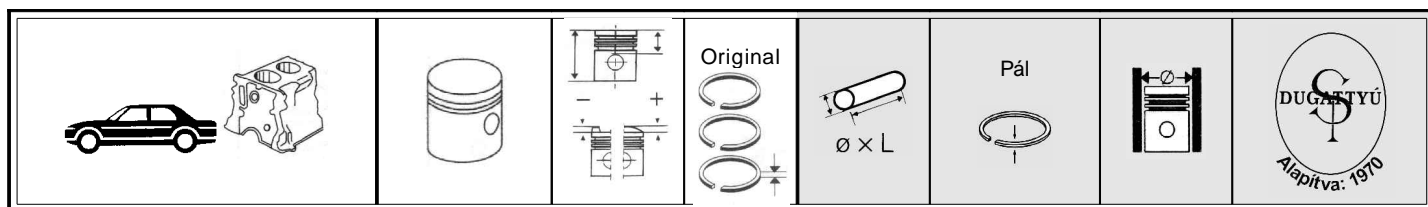

MITSUBISHI 4G62 1795 cm ³ benzin turbo 1984- Cordia 87	16 4 80,6	 71,5 24,4 -0,2	1,5 1,5 4	21x72	1,5-1,5-4 1,5-1,75-3	Ø80,6 Ø81,0	05947 05949

MITSUBISHI 4G62 1795 cm ³ benzin 1980- Cordia, L300 87	17 4 80,6	 71,9 24,4 +1,5	2 2 4	21x72	2-2-4 1,5-2- 3,947 1,5-1,75-3 1,5-1,75-3	Ø80,6 Ø80,6 Ø81,0 Ø81,5	7290-0011 07289 01269 07291

MITSUBISHI 4D65 T 1795 cm ³ diesel turbo 1984- Galant, Lancer, 88 Colt, Spacewagon	18 4 80,6	 78,8 29,3 -1,0 -1,2 -2,1	ft2 ft2 4	25x68	2-2-3 2-2-3 2-2-3 ft2-ft2-4 ft2-ft2-4	Ø80,0 Ø80,5 Ø81,0 Ø81,1 Ø81,6	06455 06451 06453 07300 07302

MITSUBISHI 4D65 T 1795 cm ³ diesel turbo 1988- Galant, Lancer, Colt, Spacewagon	19 4 80,6	 78,7 29,2 -3,3	ft2 ft2 4	25x68	2-2-3 2-2-3 1,5-1,75-3 ft2-ft2-4	Ø80,5 Ø81,0 Ø81,5 Ø81,6	02700 01271 8170 07293

MITSUBISHI 4G61 1596 cm ³ benzin 16V 1988- Colt	20 4 82,3	 62,8 22,0 +1,4	1,2 1,5 3	21x66	1,2-1,5-3 1,5-2- 3,947 2-2-3	Ø82,3 Ø82,8 Ø83,0	8360-0011 8360-5031 8360-7031

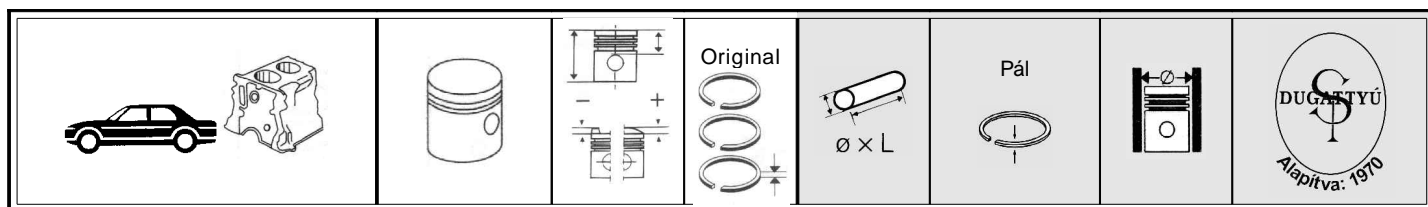

MITSUBISHI 4G52 1995 cm ³ benzin	21	4 84,0		81,5 30,25	2 2 4	22x72	1,5-2- 3,947 1,5-2- 3,947	Ø84,0 Ø84,4	07304 05157

MITSUBISHI 4G63 DOHC 16V 1997 cm ³ benzin	22	4 85,0		69,35 24,35 -5,0	1,2 1,5 3	21x66	1,5-1,5-4 1,5-1,5-4 2-2-4	Ø85,0 Ø85,5 Ø86,0	05967 05969 04652

MITSUBISHI 4G63 A 1997 cm ³ benzin	23	4 85,0		72,2 24,5 -0,9	2 2 4	21x66	1,5-1,5-4 1,5-1,5-4 1,5-1,5-4	Ø85,0 Ø85,5 Ø86,0	5240-0031 5240-5031 5240-1031

MITSUBISHI 4G63 B 1997 cm ³ benzin	24	4 85,0		72,2 25,0 -4,9 -6,9 -0,9	2 2 4	21x66	1,5-1,5-4 1,5-1,5-4 1,5-1,5-4	Ø85,0 Ø85,5 Ø86,0	03366 03368 04636

MITSUBISHI 4G63 T 1997 cm ³ benzin turbo	25	4 85,0		72,0 24,6 -5,0	1,5 1,5 4	21x66	1,5-1,5-4 1,5-1,5-4 1,5-1,5-4	Ø85,0 Ø85,5 Ø86,0	04721 03086 04723

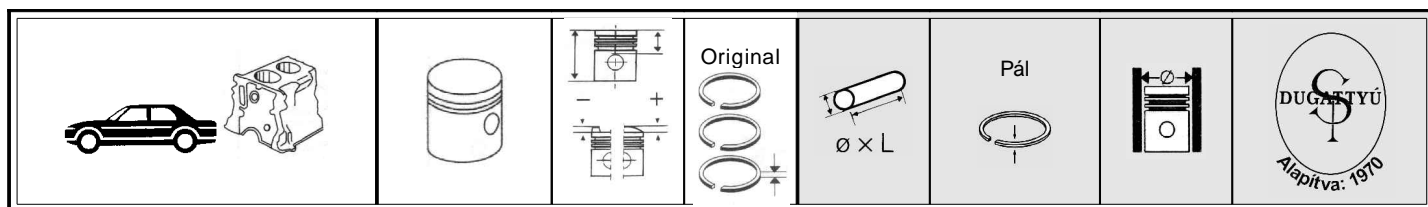



mitsubishi 4G63 S 1997 cm ³ benzin	26	4 85,0		72,0	2	21x66	1,5-1,5-4	Ø85,0	05237 01279 01281
				24,5 +2,0	2 4		1,5-1,5-4 1,5-1,5-4	Ø85,5 Ø86,0	
1980- Lancer 1981- Galant 1985- L300, Spacewagon									

mitsubishi 4G63 1997 cm ³ benzin	27	4 85,0		67,4	1,2	22x62	1,5-1,5-4	Ø85,0	8361-0031 8361-5031
				24,4 -1,6	1,5 3		1,5-1,5-4 1,5-1,5-4	Ø85,5	
1992- L300 P3									

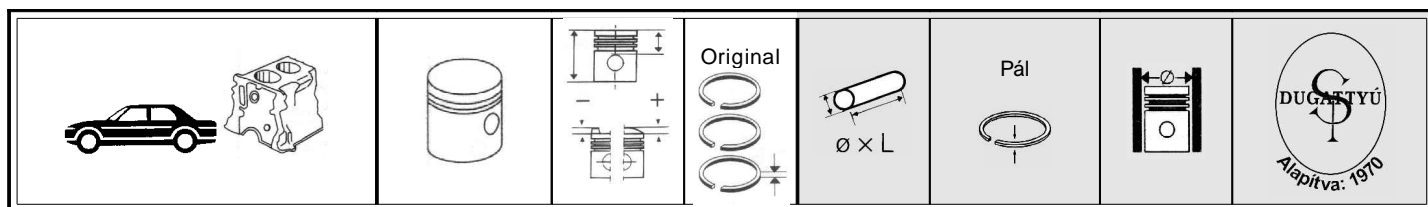
mitsubishi 4D55 2346 cm ³ diesel	28	4 91,1		88,5		29x75	3-2-4	Ø91,0	T1993 T1995 T1997
				34,2 -3,0 -2,8 -2,2	2 2 4		3-2-4 3-2-4 3-2-4	Ø91,5 Ø92,0	
1981- Galant, L300 86 1983- Pajero, Canter 86									
4D56 2476 cm ³ diesel									
1986- L300 88 1986- Pajero									

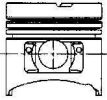
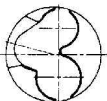

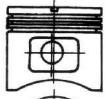
MITSUBISHI 4D55 T 2346 cm ³ diesel turbo 1981- L300, Galant 86 1983- Pajero, Canter 4D56 T 2477 cm ³ diesel turbo 1986- L300 1986- Pajero	29	4 91,1 		88,8 34,2 - 3,0 - 2,6 - 2,3	fT2,5 fT2 4	29x75	fT2,5-fT2- 4 fT2,5-fT2- 4 T2,5-2-4	Ø91,1 Ø91,6 Ø92,0	01287 01289 01291

MITSUBISHI 4G54 2555 cm ³ benzin 1983- Pajero 1985- Magna, Triton 94	30	4 91,1 		77,4 24,4	2 2 4	22x78	2-2-4 3-2-4 2-2-4	Ø91,1 Ø91,5 Ø92,0	07310 01285 06573