

RENAULT

cm ³	∅	Motor	Cylinder	Index
845	58,0	Benzin	4	1
956	65,0	Benzin	4	2
1108	70,0	Benzin	4	4
1149	69,0	Benzin	4	3
1171	75,8	Benzin	4	9
1171	75,8	Benzin	4	10
1218	75,0	Benzin	4	8
1237	71,5	Benzin	4	5
1239	74,0	Benzin	4	7
1289	73,0	Benzin	4	6
1360	75,0	Benzin	4	8
1390	75,8	Benzin	4	11
1397	76,0	Benzin	4	12
1397	76,0	Benzin turbo	4	13
1397	76,0	Benzin turbo	4	14
1397	76,0	Benzin	4	15
1565	77,0	Benzin	4	16
1565	77,0	Benzin turbo	4	17
1565	77,0	Benzin	4	18
1596	78,0	Diesel	4	19
1598	79,5	Benzin	4	22
1647	79,0	Benzin	4	20
1647	79,0	Benzin	4	21
1721	81,0	Benzin	4	24
1721	81,0	Benzin	4	25
1870	80,0	Diesel	4	23
1995	88,0	Benzin	4	28
1995	88,0	Benzin	4	29
2068	86,0	Diesel turbo	4	26
2165	88,0	Benzin	4	29
2165	88,0	Benzin	4	30
2188	87,0	Diesel	4	27
2445	93,0	Diesel turbo	4	32
2499	93,0	Diesel	4	33
2499	93,0	Diesel turbo	4	34
2664	88,0	Benzin V6	6	31

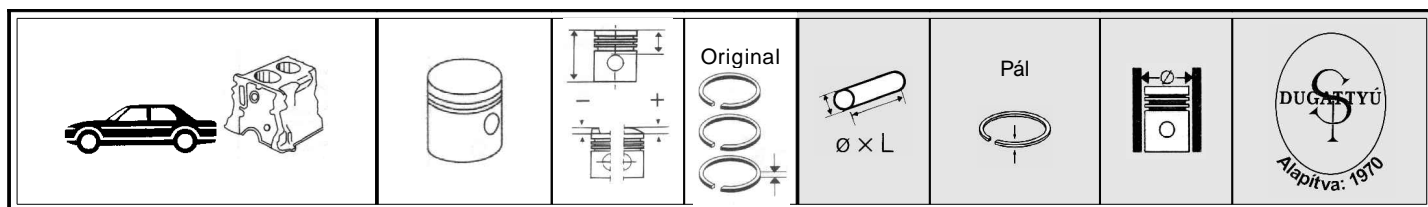

RENAULT 800/10 845 cm ³ benzin 1968- 86 R 4, R 6/850, 1972- 86 R 1123, R 2106 R 5, R 1221	1 4 58,0	 	64,0 22,0	1,75 2 3,5	16x50	1,75-2-3,5 2-2-3,18	Ø58,0 Ø58,5	8210-0011 8210-5031

RENAULT 689/10 956 cm ³ benzin 1972- 86 R5 1972- 79 R1222, R2382	2 4 65,0	 	68,5 31,0 +5,4	1,75 2 3,5	18x56	1,75-2-3,947 1,75-2-3,947 1,75-2-3,947 1,75-2-3,947	Ø65,0 Ø65,4 Ø65,6 Ø66,0	7078-0031 7078-4031 7078-6031 7078-1031

RENAULT D 7 F 1149 cm ³ benzin 1996- Clio 1998- Kangoo	3 4 69,0	 	50,5 18,35	1,5 1,5 2,5	17,5x54	1,5-1,5-2,5 1,5-1,5-2,5 1,5-1,5-3	Ø69,0 Ø69,5 Ø70,0	8250-0011 8250-5011 8250-1031

RENAULT 688/01/02/03/10/11/12 /C7/ C1E 1108 cm ³ benzin 1962- R4, R5, R6, R8, R9, R10, R11, ...	4 4 70,0	 	68,0 31,0	1,75 2 3,5	18x62	1,75-2-4 1,75-2-4	Ø70,0 Ø70,5	1784-0031 1784-5031

RENAULT C1G 1237 cm ³ benzin R5, R9, R11	5 4 71,5	 	62,5 27,5	1,75 2 4	20x63	1,75-2-4 2-2-4 2-2-4	Ø71,5 Ø72,0 Ø72,5	6889-0011 6889-5031 6889-1031

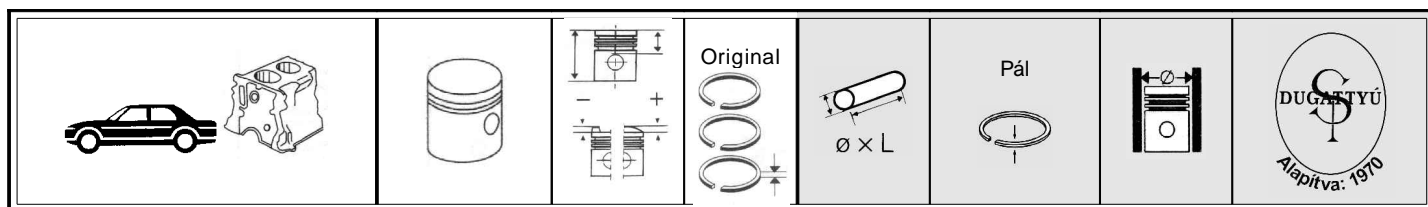





RENAULT 810/25/26/29/03 1289 cm ³ benzin 1970- R10 75 1970- R5, R12 85 1972- Alouette, R6, R15 80	6	4 73,0 	63,0 27,5	1,75 2 4	20x63	1,75-2-4 1,5-2- 3,947	Ø73,0 Ø73,5	2622-0011 2622-5031

RENAULT C3G 1239 cm ³ benzin 1993- Twingo	7	4 74,0 	61,0 31,05	1,5 1,75 3	18x62	1,6-2-4 1,6-2-4	Ø74,0 Ø74,5	6221-0031 6221-5031

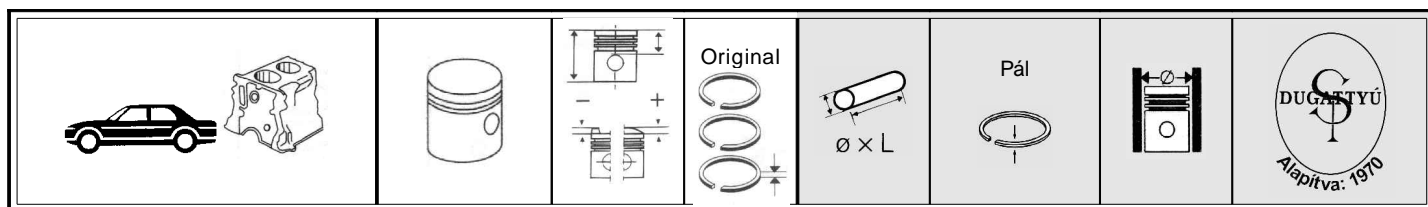
RENAULT 129 A 7.00, XV 6B 1218 cm ³ benzin 1976- R14, R1210, 83 R1212, R1170, R1330 150 A 700 1360 cm ³ benzin 1980- R14 94	8	4 75,0 	65,5 30,75	1,75 2 4	19,5x65	1,75-2-4 1,75-2-4 1,5-2- 3,947	Ø75,0 Ø75,5 Ø76,0	2661-0011 2661-5011 2661-1031

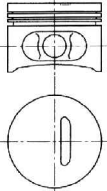
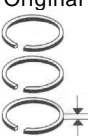
RENAULT E 5 F 1171 cm ³ benzin 1992- Clio 94	9	4 75,8 	56,4 25,58 -1,23	1,5 1,75 3	19x60	1,5-1,75-3 1,75-2-3	Ø75,8 Ø76,5	8132-0011 8132-7031

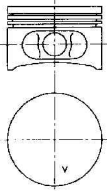
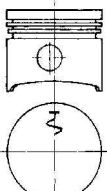
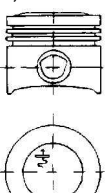

RENAULT E 7 F 1171 cm ³ benzin 1995- Clio	10	4 75,8 	56,6 25,79 -1,44	Original  1,5 1,75 3	 $\varnothing \times L$ 19x60	Pál  1,5-1,75-3 1,75-2-3	 $\varnothing 75,8$ $\varnothing 76,5$	 8122-0011 8122-7031
RENAULT E 6 J, R 7 J, E 7 J 1390 cm ³ benzin 1989- R19 1991- Clio 1997- Kangoo	11	4 75,8 	52,6 22,2	1,5 1,75 3	19x60	1,5-1,75-3 1,5-1,5-2,8 1,2-1,5-3	$\varnothing 75,8$ $\varnothing 76,5$ $\varnothing 76,5$	8160-0011 8160-7031 8160-7041
RENAULT 847.20/21, C 1 JJ15, C 2 J.L.17, C 2 J.N.18, C 3 JA.710, C 3 J 720/760, C 16 1397 cm ³ benzin 1978- R18, Fuego, T550 87 1981- R12 85 1981- R5, R9, R19	12	4 76,0 	62,2 27,6	1,75 2 4	20x64	1,5-2-3,947 1,5-2-3,947 1,5-2-3,947	$\varnothing 76,0$ $\varnothing 76,4$ $\varnothing 76,6$	4600-0031 4600-4031 4600-6031
RENAULT C 1 J 1397 cm ³ benzin Turbo R5, R9, R11, turbo	13	4 76,0 	63,5 27,5 +1,0	1,75 2 4	20x61	1,5-2-3,947 1,5-2-3,947	$\varnothing 76,0$ $\varnothing 76,4$	2612-0031 2612-4031

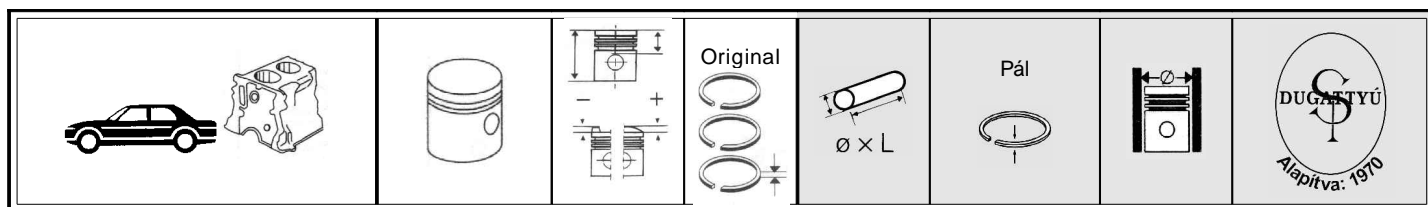

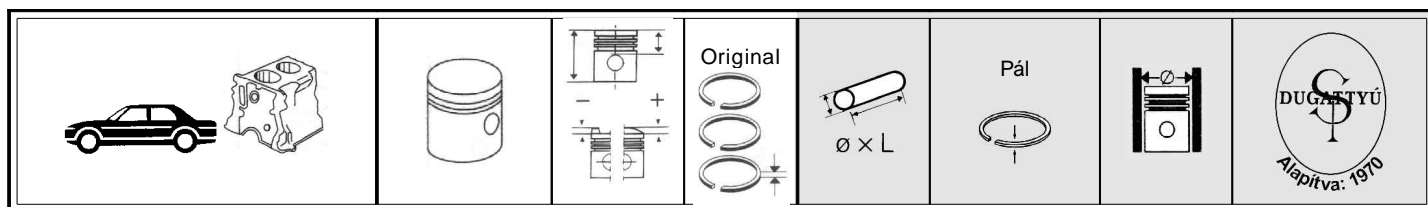

RENAULT 840.26 1397 cm ³ benzin Turbo 1980- R5 Alpine Turbo 85	14 4 76,0	 	65,5 26,05 +4,45	1,75 2 4	20x65	1,5-2-3,947 1,5-2-3,947 1,75-2-3 1,5-2-3,947 1,5-2-3,947	Ø76,0 Ø76,4 Ø76,5 Ø76,6 Ø77,0	1790-0031 1790-4031 1790-5031 1790-6031 1790-1031
RENAULT 840.25 1397 cm ³ benzin 1977- R5 Alpine	15 4 76,0	 	69,0 27,5 +5,0	1,75 2 4	20x63,5	1,5-2-3,947 1,5-2-3,947	Ø76,0 Ø76,4	4099-0031 4099-4031
RENAULT 821.02 1565 cm ³ benzin 1972- R15, R17 77	16 4 77,0	 	66,0 30,6 +0,7	1,75 2 4	21x66	2-2-3,947 2-2-3,947	Ø77,0 Ø77,4	3712-0031 3712-4031
RENAULT 1565 cm ³ benzin Turbo Fuego1600, R18	17 4 77,0	 	67,0 30,6 -3,6	1,75 2 4	21x60	2-2-4 2-2-4	Ø77,0 Ø77,5	5610-0031 5610-5031
RENAULT R 821.01/02/03/04 1565 cm ³ benzin 1969- R16, R 1152, 80 R 1153	18 4 77,0	 	67,1 30,6	1,75 2 4	20x59	2-2-3,947 2-2-3,947 2-2-3,947	Ø77,0 Ø77,4 Ø77,6	7086-0031 7086-4031 7086-6031

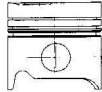

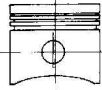
RENAULT F 8 M 1596 cm ³ diesel	19	4		74,5 35,25 - 1,5	2 2 3	24x67	2-2-3 2-2-3 2-1,5-3 1,75-2-3	Ø78,0 Ø78,5 Ø79,0 Ø79,5	2235-0011 2235-5011 2235-1031 2235-1531
		78,0							

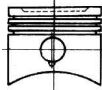

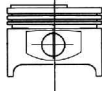
RENAULT 845.25/26/C7/D7 1647 cm ³ benzin	20	4		65,9 30,0	1,75 2 4	21x68	1,5-2-3,947 1,75-2-4 1,5-2-3,947	Ø79,0 Ø79,5 Ø79,7	2632-0031 2632-5011 2632-7031
		79,0							

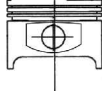

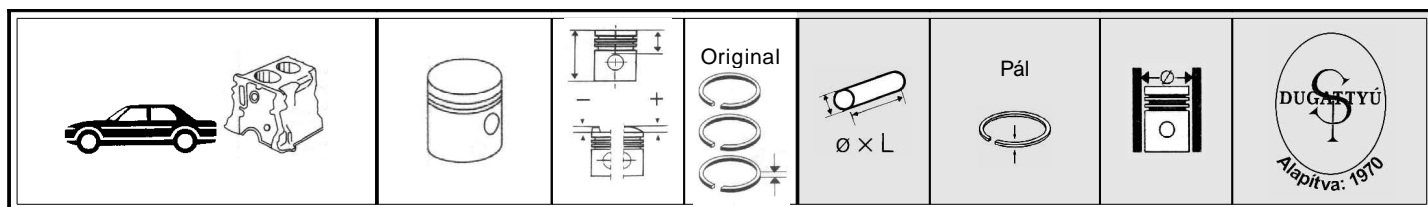
RENAULT 841.99 A1M 1647 cm ³ benzin	21	4		66,5 30,6 - 4,8	1,75 2 4	21x68	1,5-2-3,947 1,5-2-3,947 1,5-2-3,947	Ø79,0 Ø79,7 Ø80,0	4648-0031 4648-7031 4648-1031
		79,0							

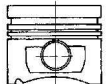
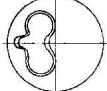
RENAULT K 7 M 1598 cm ³ benzin	22	4		56,5 19,8 +2,7	1,5 1,5 2,5	19x65	1,5-1,5-2,5 1,2-1,5-3 1,2-1,5-3	Ø79,5 Ø79,5 Ø80,0	1-2 Cyl
		79,5							
1995- Megane 1998- Clio, Scenic							1,5-1,5-2,5 1,2-1,5-3 1,2-1,5-3	Ø79,5 Ø79,5 Ø80,0	3-4 Cyl 8366-0011 8366-0031 8366-5031

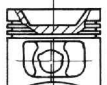

RENAULT F 8 Q 1870 cm ³ diesel 1989- R19, R21 1991- Clio 1997- Kangoo	23	4	 	80,0	70,0 30,5 -0,7	2 2 3	24x63	2-2-3 2-2-3 2-2-3	Ø80,0 Ø80,5 Ø81,0	2247-0011 2247-5011 2247-1011

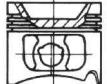
RENAULT F 2 NC 710, F 2 N-A700/704 F 2 N 700, F 2 N-E708, F 3 N-746 1721 cm ³ benzin 1984- R9, R11, R21	24	4	 	81,0	70,0 33,6 -13,4	1,75 2 3	21x66	1,5-1,75-3 1,5-1,75-3 1,5-2-3,947	Ø81,0 Ø81,5 Ø82,0	3090-0031 3090-5031 3090-1031

RENAULT F2N C 710/732/742/753 F 3NC 722 1721 cm ³ benzin 1989- R19 1990- R21	25	4	 	81,0	70,2 33,7 -14,26 Perem: 11,0	1,75 2 3	21x58	1,5-1,75-3 1,5-1,75-3	Ø81,0 Ø81,5	7092-0031 7092-5031

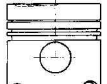
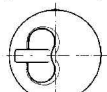
RENAULT J 8 S 708/712/714 2068 cm ³ diesel Turbo 1981- R18, R20, R21, R25, R30, Fuego, Espace 1988- Nevada 95	26	4	 	86,0	92,0 36,99 -4,0	2,5 2,5 4	28x74	2-2-4 2-2-4 2-2-4	Ø86,0 Ø86,5 Ø87,0	1818-0031 1818-5031 1818-1031

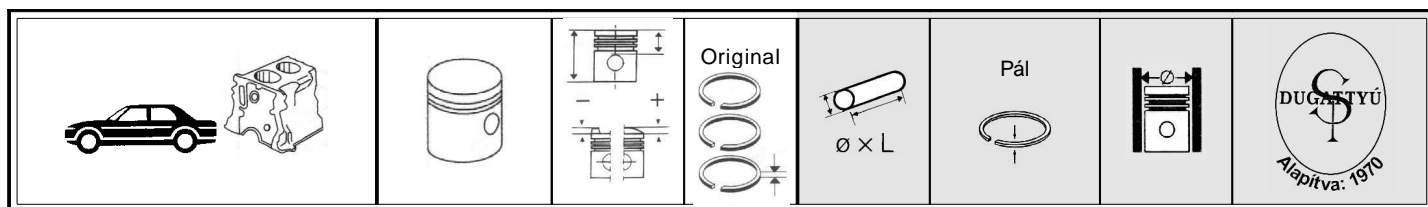

RENAULT G 8 T 794 3V 2188 cm ³ diesel 1994- Laguna	27 4 87,0	 	75,0	2,5	28x68	3-2-4	Ø87,0	8166-0031 8166-5031
			30,98 -3,05	1,75 2,5		3-2-4	Ø87,5	

RENAULT J5 R 1995 cm ³ benzin 1981- Master, Trafic	28 4 88,0	 	65,5	1,75	23x72	2-2-5	Ø88,0	07096 04511
			29,0 -1,3	2 4		2-2-5	Ø88,5	

RENAULT 829 E7, J5R A 7, 829.00/01 1995 cm ³ benzin Trafic, Minicar, P1200, P1400 1979- R 18, R20, Fuego, 85 R1363, R135 300 1983- R25, Escape J7 TV, J7 T770, J7 R 2165 cm ³ benzin 1983- Escape, R25	28 4 88,0	 	66,0	1,75	23x75	2-2-4	Ø88,0	02592 02594
			29,0 +1,55	2 4		2-2-4	Ø88,5	

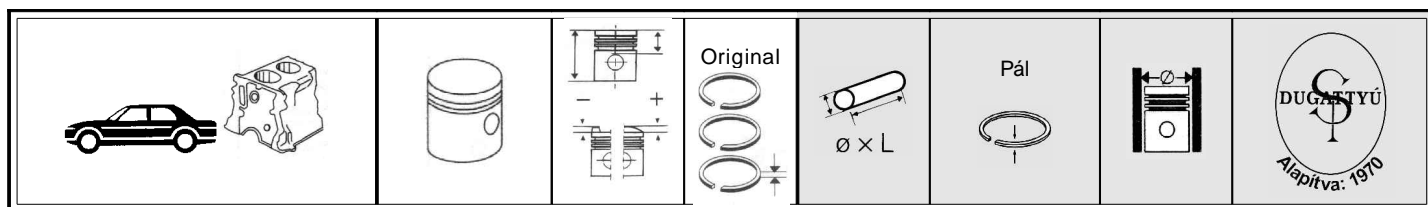

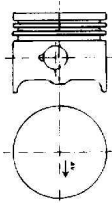

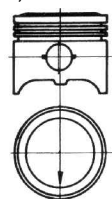
RENAULT J7 T, J7 T 780/780 ZDK 2165 cm ³ benzin 1980- R20, R21 83 1986- R25, Trafic 91 Master 1990-	30 4 88,0 	69,0 29,0	1,75 2 4	23x75	2-2-4 2-2-4 1,75-2-4	Ø88,0 Ø88,5 Ø89,0	06885 01828 01830

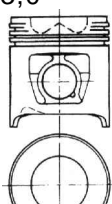
RENAULT 140.40, 144 2664 cm ³ benzin V6 1978- R25, R30	31 6 88,0 	67,75 26,5 +1,96	1,5 2 4	23,5x72	2-2-4 2-2-4	Ø88,0 Ø88,5	07094 01826

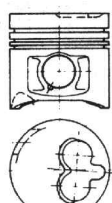
RENAULT 8140.21, 8144.21 2445 cm ³ diesel turbo 1986- Master, B90 88	32 4 93,0 	97,65 43,65 -14,8	T3 2 3	32x75	T3-2-3 T3-2-3 T3-2-3 2-2-4	Ø93,0 Ø93,4 Ø93,6 Ø94,0	06675 06677 06679 06681

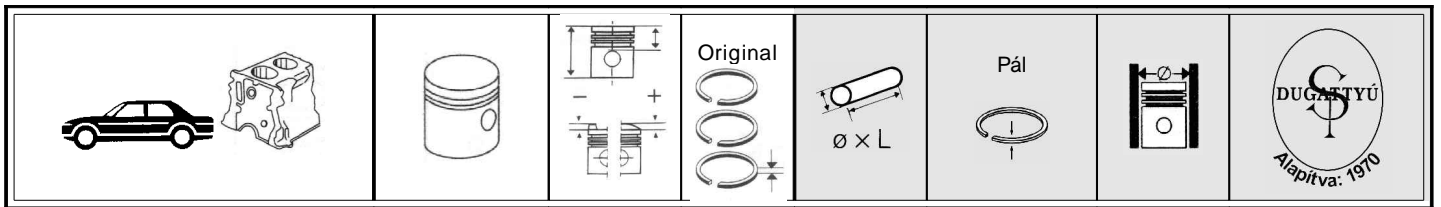
RENAULT S 8 W, 732/742, 8140.67.2500, S 8750/753 2499 cm ³ diesel 1985- Master 94	33 4 93,0 	89,0 38,0 -2,2	3 2 3	32x75	2,5-2-4 3-2-4 2,5-2-4 3-2-4 2-2-4	Ø93,0 Ø93,4 Ø93,5 Ø93,6 Ø94,0	06401 06407 06403 06409 06405

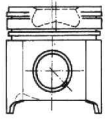

RENAULT 8140.27.2700 2499 cm ³ diesel turbo 1990- Master, B90-35D 93	34 4 93,0  	96,75 42,75 - 17,9 KØ=38,0	T3 2 3	30x75	T3-2-3 T3-2-3 2,5-2-4 T3-2-3 2-2-4	Ø93,0 Ø93,4 Ø93,5 Ø93,6 Ø94,0	06395 06815 06397 06817 06399
--	---	-------------------------------------	--------------	-------	--	---	---